



Part No.: NFP-N20-4.5V

Technical Requirements:

- | | | |
|----|------------------------|-----------------|
| 1 | Rated Voltage: | 4.5V DC |
| 2 | Operating Voltage: | 3.0-5.0V DC |
| 3 | Rated Current: | ≤45mA |
| 4 | Rated Speed: | 52rpm±15% |
| 5 | Stall Current: | ≤620mA |
| 6 | Starting Voltage: | ≤2.0V DC |
| 7 | Stall Torque: | 1.8Kg.cm (ref.) |
| 8 | Axial End Play: | 0.05~0.3mm |
| 9 | Unmarked tolerance: | ±0.1mm |
| 10 | Operating Temperature: | -30°C ~ +70°C |

Mechanical Drawing (scale 4:1):

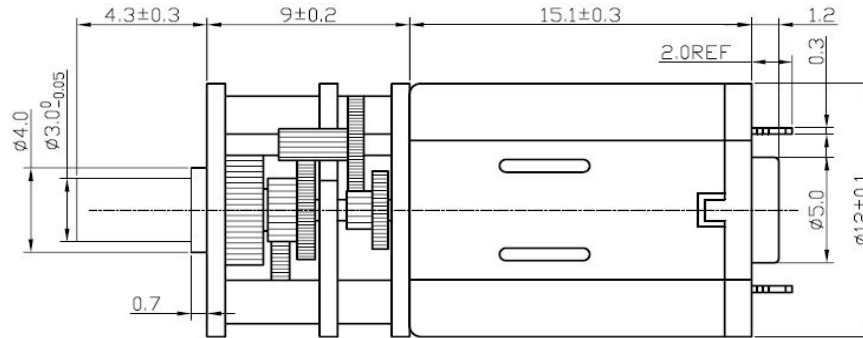
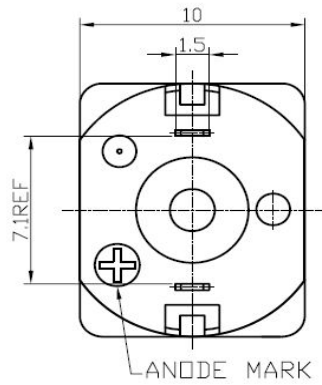

DIRECTION OF
ROTATION

